

Creative Werks Inc. LIMITED WARRANTY STATEMENT

Creative Werks Inc. warrants this product to be free from defects in material and workmanship for a period of one (1) year from the date of sale to the original purchaser. Creative Werks Inc. will repair this product free of charge if, in the judgment of Creative Werks Inc., it has been proven defective within the warranty period. The product should be returned, at the customer expense, to the location of original purchase. This warranty does not cover any expenses incurred in the removal and/or reinstallation of the product.

This warranty does not apply to any product damaged by improper installation, accidental misuse, abuse, improper line voltage, fire, flood, lightning, or other acts of God, or a product altered or repaired by anyone other than Creative Werks Inc.. This warranty is in lieu of other warranties, expressed or implied, including any implied warranty of merchantability. No person is authorized to assume for Creative Werks Inc. any other liability concerning the sale of this product.

IMPORTANT-KEEP YOUR INVOICE WITH THIS WARRANTY STATEMENT!



DESIGNinMOTION

1434 E. Flemming Ave.

Des Moines, IA 50313

T. 515•264•8222

F. 515•264•8444

www.creativewerksinc.com



CREATIVE
WERKS inc.

DESIGNinMOTION

www.creativewerksinc.com

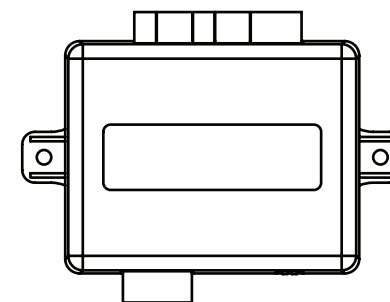
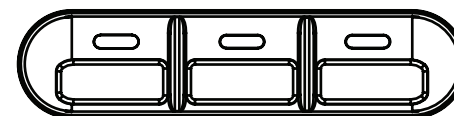

Dual Linear Actuator Controller

LA-Dual Controller

Installation Manual & Operation Instructions

Each Kit Contains the Following Components:

(1) Display



(1) Central Control Unit

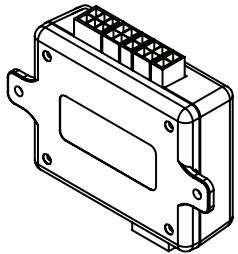

(1) Wire Harness

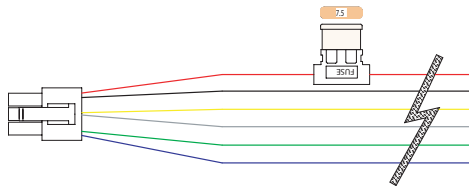

(1) Double-Sided Tape



(1) Mounting Hardware

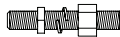
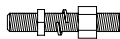
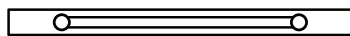

(1) Display Harness

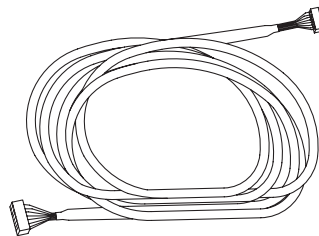

Optional Accessories

- 10' Linear Actuator Extension Harness, Mounting Brackets
- Linear Actuators 2, 4, 6, 8, 10, 12-Inch

Explanation:

This unit features 3 user programmable presets that are easily accessed via the push-button display to precisely control 1 or 2 actuators individually or in sequence. Linear actuators can be used to open trunks, hoods, etc.

****Proper wiring is critical to the correct operation of this unit. Inspect all wiring to be certain of proper connections, a good quality ground, and proper fusing. Also check wire routing, keeping wires away from potential damage, such as moving parts.****

Optional Wiring

Wiring Diagram

Shaved Door Kit & LA Controller

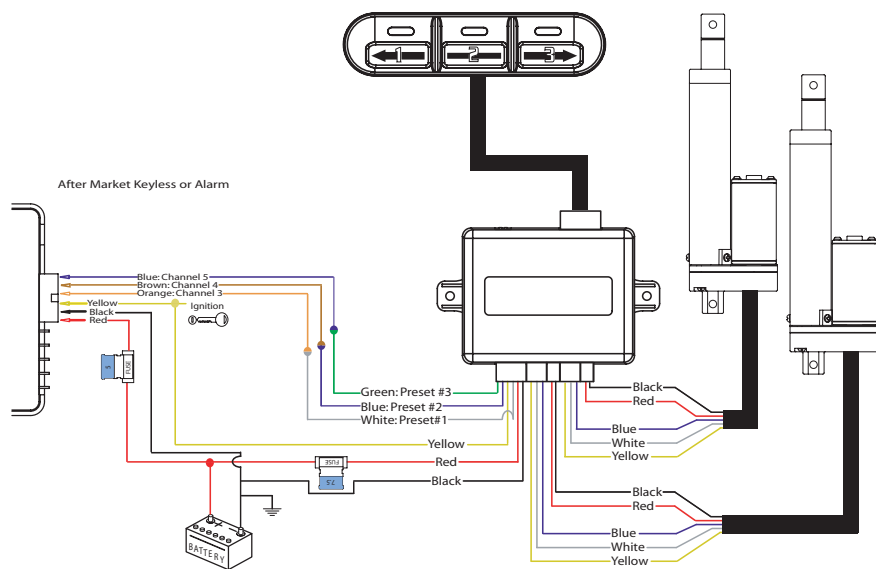

Custom Buttons

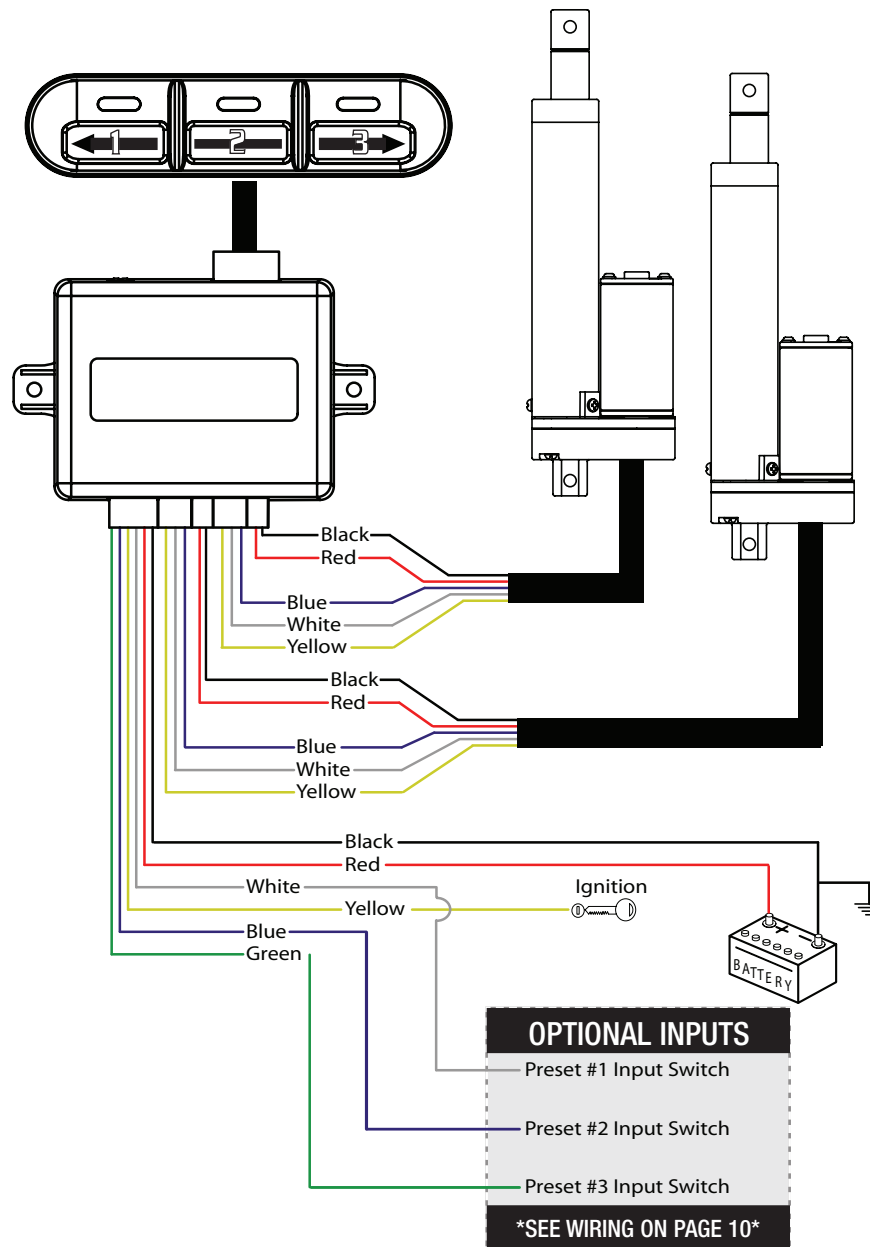
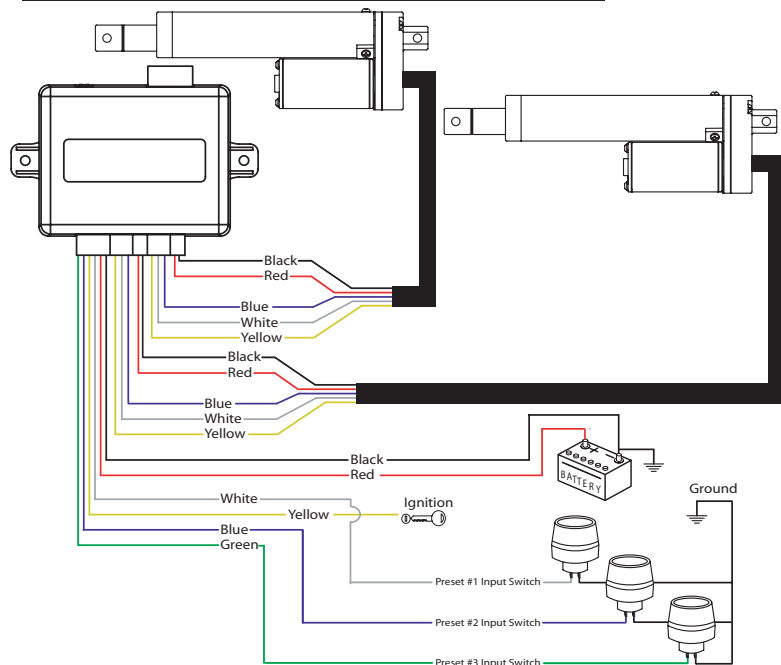

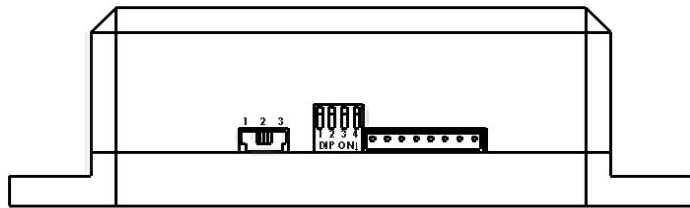

Position 1: Actuator 1

Position 2: Both actuators

To program the actuators first set the switch in position 1 and retract the actuator then place the switch in position 3 and retract that actuator.

Position 3: Actuator 2

To move the Actuator(s) in and out:

1-Press buttons 2 and 3 to make the actuator(s) extend



2-Press buttons 1 and 2 to make the actuator(s) retract



To Program Presets #1, 2, and 3:

3-Extend the actuator(s) to where you would like the Preset #1 to be located.



DIP SWITCH

FUNCTION

#3

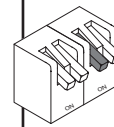

ON

2 Stage feature **ON**. This feature works after programming actuators at starting point and end point. Once in the run mode, pressing Button 1 will initiate the two stage sequence by moving Actuator 1 from the preset starting point to the end point. Once Actuator 1 has reached its end point, Actuator 2 will begin moving from the preset starting point to the end point. Pressing Button 3 will reverse the sequence, retracting Actuator 2 first, and then retracting Actuator 1; moving both back to the starting point. Pressing Button 2 will only move the actuators one stage. For example, after pressing Button 2, if the actuators are at the starting point, the controller will only move Actuator 1 from the starting point to the end point. If the actuators are at the end points, after pressing Button 2 the controller will only move Actuator 2 from its end point to the start point. Pressing Buttons 1 or 3 after pressing Button 2 will complete the second stage of the sequence.

OFF

2 Stage **OFF**

#4

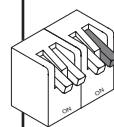

ON

Retreat Safety **ON**. In this feature, the controller will be able to sense if an object or something is in the way and is preventing the actuator from completely retracting. The controller will do a speed check after reading current actuator position value, retract a little and do another speed check. Speed check will respond "normal" or "error" If there is an error, actuators are to stop immediately and extend to its max preset.

OFF

Retract Safety **OFF**.

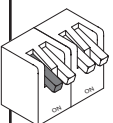
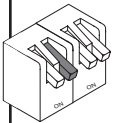
DIP SWITCH	FUNCTION	ACTION	REASON/EXAMPLES
#1 	OFF Operates only when ignition IS present.	The unit will operate only when the yellow ignition wire receives +12VDC	If you want to control items when the ignition is ON .
	ON Operates only when ignition is NOT present.	The unit will operate only when the yellow ignition wire is NOT receiving +12VDC	If you want to raise/lower your trunk when the car is OFF .
#2 	OFF Auto return to preset #1 with loss of ignition.	When +12VDC is removed from the yellow ignition wire the linear actuator will travel to preset #1.	If you want your trunk, running boards, steering column, etc. to move automatically when you turn the ignition ON/OFF .
	ON Auto return to preset #2 with ignition.	When the yellow ignition wire receives +12VDC the linear actuator will travel to preset #2.	
OFF	Nothing happens with ignition cycle.	When the key is turned on then off the linear actuator will remain at the same location.	If you do not want automatic movement when you turn the vehicle on and off.

4-Press and hold the Number 1 button for 5 seconds
 -The LED will flash to indicate setting has been learned



5-Extend or retract the actuator(s) to where you would like Preset #2.



6-Press and hold the Number 2 button for 5 seconds
 -The LED will flash to indicate setting has been learned



7-Extend or retract the actuator(s) to where you would like Preset #3.



8-Press and hold the Number 3 button for 5 seconds
 -The LED will flash to indicate setting has been learned



The presets can be at any position throughout the stroke of the actuator. They do not have to be in order. Nor do they have to be programmed in order.

Dual Actuator Sequence Programming

Wiring Diagram

For Actuator #1:
Slide switch to position 1

To move the Actuator in and out:

1-Press buttons 2 and 3 to make the actuator extend



2-Press buttons 1 and 2 to make the actuator retract



Set Presets 1 and 2

3-Extend the actuator to where you would like the Preset #1 to be located



4-Press and hold the Number 1 button for 5 seconds
-The LED will flash to indicate setting has been learned



5-Extend or retract the actuator to where you would like Preset #2



6-Press and hold the Number 2 button for 5 seconds
-The LED will flash to indicate setting has been learned



Slide switch to Act 2 (actuator 2) and repeat steps 1-6

Flip dip switch #3 to the on position and the unit is programmed. Pressing preset 1 will send actuator number 1 to the set position and then actuator 2 will follow to its preset position. Pressing preset 2 will retract the actuators back to their starting position.

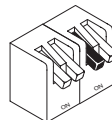

Mounting:

The Main Control Unit and the Display must be mounted inside the vehicle to avoid moisture. Do not plug in the Main Control Unit until all wiring is complete.

Display:

The Display can be mounted in a variety of ways. Below you will find our suggested mounting options.

Double-Sided Tape:

Use the supplied double-sided tape to mount the display to any flat surface.

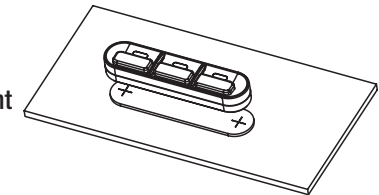

Mounting Bolts:

Use the supplied mounting bolts for a more secure mounting option. The double-sided tape or the support bracket can be used as a template for marking and drilling the mounting holes.

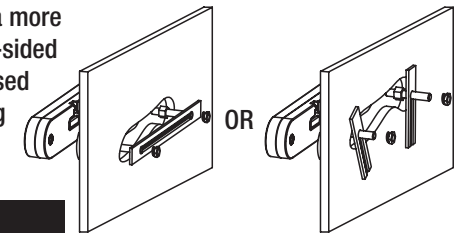

Reversible Rear Display Panel:

The rear of the display panel is reversible so that the display harness can exit the top or the bottom of the display.

1- Remove the rear of the display by gently separating the front and rear halves. (The front and rear simply snap together and can be separated by inserting a fingernail in between the front and rear halves as indicated below)

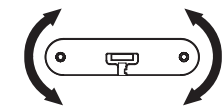
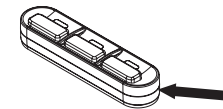

2- Reverse the rear of the display.

3- Snap the Front and Rear halves together.

