

Creative Werks Inc. LIMITED WARRANTY STATEMENT

Creative Werks Inc. warrants this product to be free from defects in material and workmanship for a period of eighteen (18) months from the date of sale to the original purchaser. Creative Werks Inc. will repair this product free of charge if, in the judgment of Creative Werks Inc., it has been proven defective within the warranty period. The product should be returned, at the customer expense, to the location of original purchase. This warranty does not cover any expenses incurred in the removal and/or reinstallation of the product.

This warranty does not apply to any product damaged by improper installation, accidental misuse, abuse, improper line voltage, fire, flood, lightning, or other acts of God, or a product altered or repaired by anyone other than Creative Werks Inc.. This warranty is in lieu of other warranties, expressed or implied, including any implied warranty of merchantability. No person is authorized to assume for Creative Werks Inc. any other liability concerning the sale of this product.

IMPORTANT-KEEP YOUR INVOICE WITH THIS WARRANTY STATEMENT!



CREATIVERWERKS inc.
.....DESIGNinMOTION



CREATIVERWERKS inc.
.....DESIGNinMOTION

1434 E. Fleming Avenue
Des Moines, IA 50313

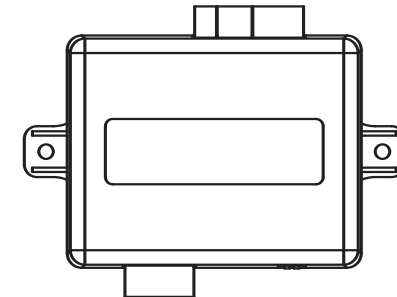
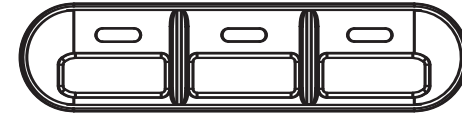

Linear Actuator Controller

LA-Controller

**Installation Manual &
Operation Instructions**

Each Kit Contains the Following Components:

(1) Display



(1) Central Control Unit

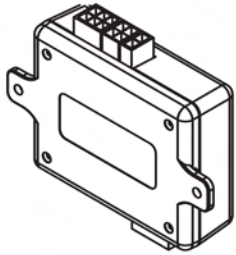

(1) Wire Harness

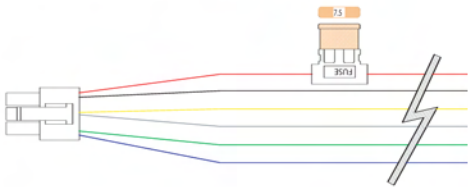

(1) Double-Sided Tape

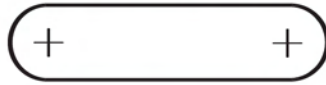

(1) Mounting Hardware



(1) Display Harness

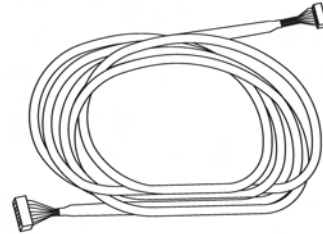

Optional Accessories

- 10' Linear Actuator Extension Harness (Part #LA-EXTHARN)
- Linear Actuators 2, 4, 6, 8-Inch

Explanation:

This unit features 3 user programmable presets that are easily accessed via the push-button display to precisely control one linear actuator. Linear actuators can be used to open trunks, hoods, etc.

Once the linear actuator has reached a point that you would like to make a preset, simply press and hold the corresponding button for 5 seconds. The position will have been learned by the main control unit and visually indicated by a led flashing above the programmed preset.

****Proper wiring is critical to the correct operation of this unit. Inspect all wiring to be certain of proper connections, a good quality ground, and proper fusing. Also check wire routing, keeping wires away from potential damage, such as moving parts.****

Optional Wiring

SPAL Shaved Door Kit & LA Controller

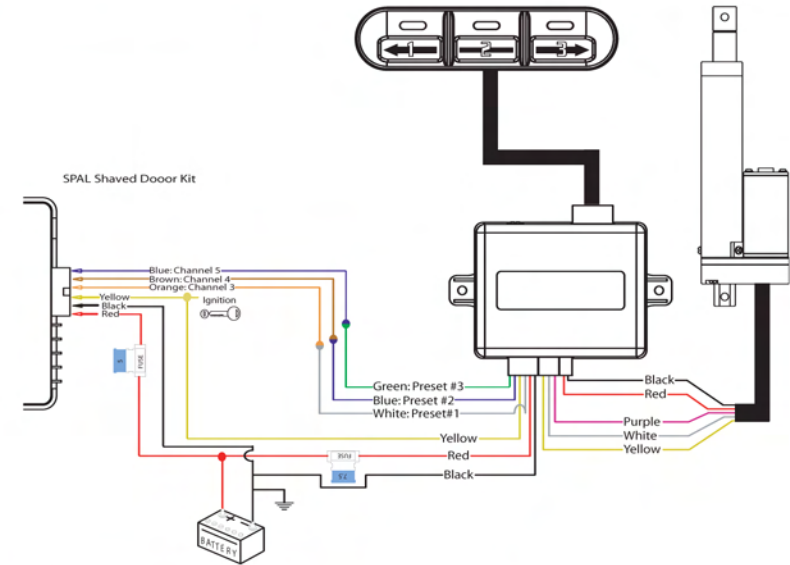

Custom Buttons

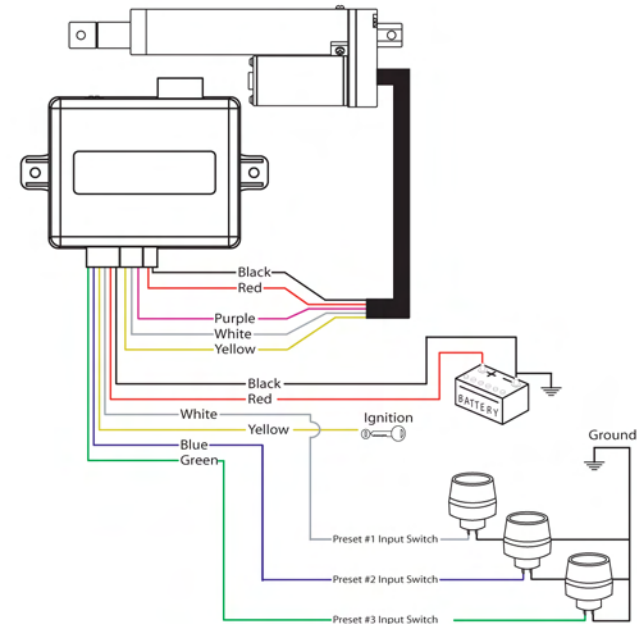

To move the Actuator in and out:

1-Press buttons 2 and 3 to make the actuator extend



2-Press buttons 1 and 2 to make the actuator retract



To Program Presets #1,2, and3:

3-Extend the actuator to where you would like the Preset #1 to be located.



4-Press and hold the Number 1 button for 5 seconds
-The LED will flash to indicate setting has been learned



5-Extend or retract the actuator to where you would like Preset #2.



6-Press and hold the Number 2 button for 5 seconds
-The LED will flash to indicate setting has been learned



7-Extend or retract the actuator to where you would like Preset #3.



8-Press and hold the Number 3 button for 5 seconds
-The LED will flash to indicate setting has been learned



The presets can be at any position throughout the stroke of the actuator. They do not to be in order. Nor do they have to be programmed in order.

Mounting:

The Main Control Unit and the Display must be mounted inside the vehicle to avoid moisture. Do not plug in the Main Control Unit until all wiring is complete.

Display:

The Display can be mounted in a variety of ways. Below you will find our suggested mounting options.

Double-Sided Tape:

Use the supplied double-sided tape to mount the display to any flat surface.

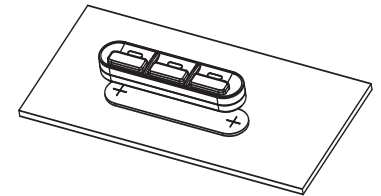

Mounting Bolts:

Use the supplied mounting bolts for a more secure mounting option. The double-sided tape or the support bracket can be used as a template for marking and drilling the mounting holes.

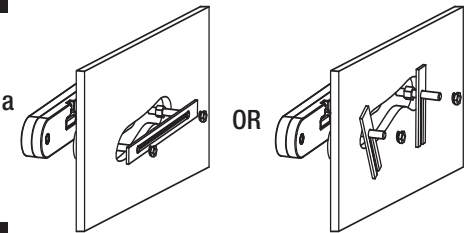

Reversible Rear Display Panel:

The rear of the display panel is reversible so that the display harness can exit the top or the bottom of the display.

1- Remove the rear of the display by gently separating the front and rear halves. (The front and rear simply snap together and can be separated by inserting a fingernail in between the front and rear halves).

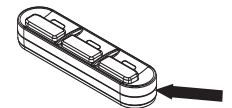

2- Reverse the rear of the display.

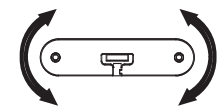

3- Snap the Front and Rear halves together.

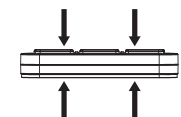

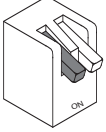
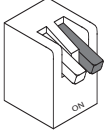
DIP SWITCH	FUNCTION	ACTION	REASON/EXAMPLES
#1 	OFF ON	Operates only when ignition IS present.	The unit will operate only when the yellow ignition wire receives +12VDC If you want to control items when the ignition is ON .
	ON OFF	Operates only when ignition is NOT present.	The unit will operate only when the yellow ignition wire is NOT receiving +12VDC If you want to raise/lower your trunk when the car is OFF .
#2 	ON OFF	Auto return to preset #1 with loss of ignition.	When +12VDC is removed from the yellow ignition wire the linear actuator will travel to preset #1. -LED will turn off after preset has been reached. If you want your trunk, running boards, steering column, etc. to move automatically when you turn the ignition ON/OFF.
	OFF ON	Auto return to preset #2 with ignition.	When the yellow ignition wire receives +12VDC the linear actuator will travel to preset #2. -LED will remain on after preset is reached.
OFF	Nothing happens with ignition cycle.	When the key is turned on then off the linear actuator will remain at the same location.	If you do not want automatic movement when you turn the vehicle on and off.

Auxiliary Inputs:

This unit has 3 Auxiliary negative inputs that can be used in conjunction with a keyless entry, alarm system, shaved door kit, etc. When a negative pulse is applied to any of these wires, the actuator will go to the specified preset.

Optional inputs cannot set preset positions, or manually move the actuators. You **WILL have to use the display panel to configure the preset locations, at which point you may remove the display.

Preset #1: White Wire **Preset #2:** Blue Wire **Preset #3:** Green Wire

